

R. Christensen  
Premium Hardware Since 1879®



ART TECH

THE FINE ART OF SELF EXPRESSION

## PERSONAL AND PRECISE

Where the classic meets the modern, the Art Tech series utilizes the sophisticated style of the past with the sleek geometry of today. Clean, simple, its defined lines and high-gloss finish gives this R. Christensen series a feeling that is both elegant and personal.

## DESIGN DELIVERED

It's critical that every element of your design comes together at the right moment. We understand, and support you with prompt, reliable and complete delivery. We'll ship in any quantity, with no minimums or broken box charges. We also make R. Christensen samples available to designers and dealers at 50% off your everyday discount.



### LOOK FOR THESE ICONS THROUGHOUT



**ISO 14001  
STANDARD**

Efficiently uses both energy and material, reducing pollutants and waste. Supports continuous improvements in environmental sustainability.



**EXTREME  
FINISHES**

Extreme finishes exceed KCMA finish standards by 10X, providing extra durability for long-lasting beauty.

THE FINE ART OF SELF EXPRESSION

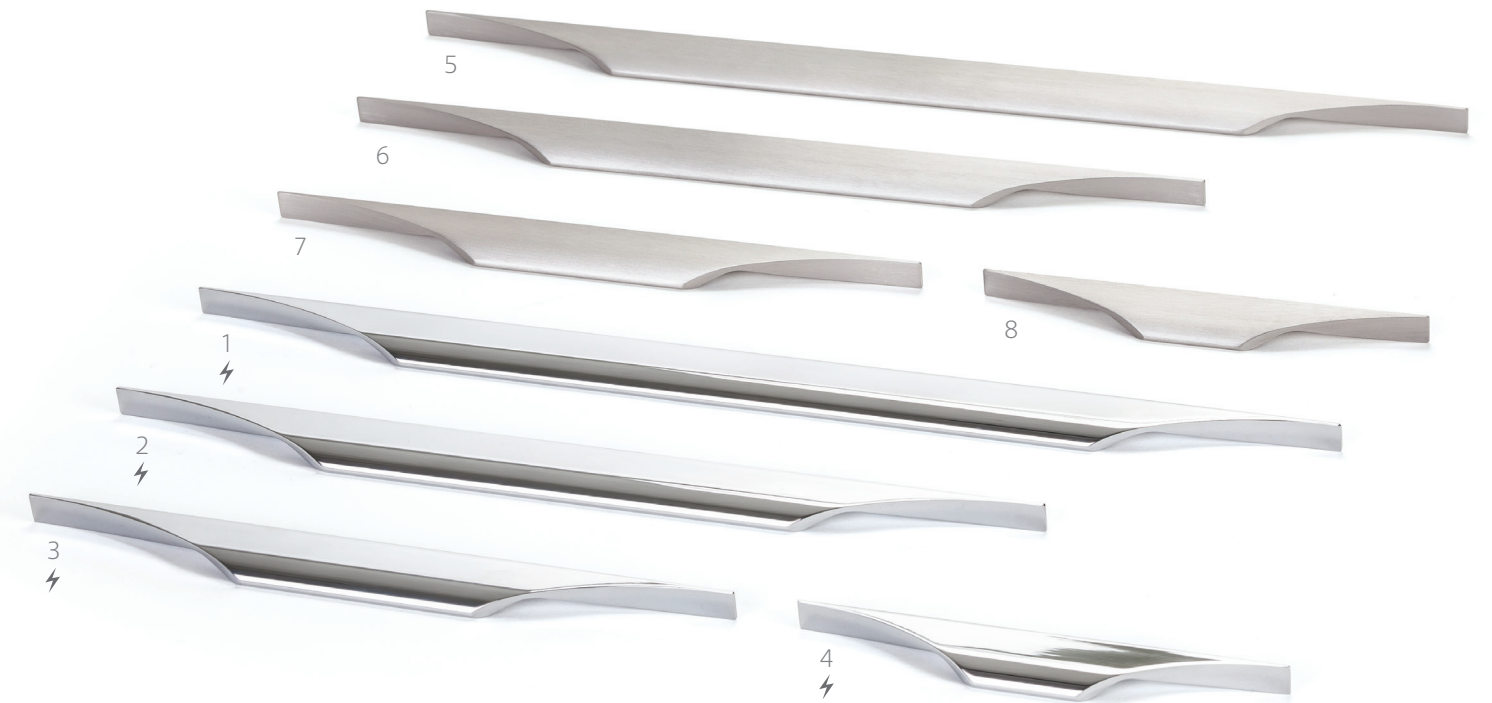

## SILHOUETTE

#	FINISH	CC	L	W	H	TAP	PART NO
1	Polished Chrome	192mm/360mm	19 5/16	9/16	1 1/16	M4	1161-4026-P
2	Polished Chrome	128mm/260mm	15 3/8	9/16	1 1/16	M4	1160-4026-P
3	Polished Chrome	160mm	11 7/16	9/16	1 1/16	M4	1159-4026-P
4	Polished Chrome	64mm	7 1/2	9/16	1 1/16	M4	1158-4026-P
5	Stainless Steel	192mm/360mm	19 5/16	9/16	1 1/16	M4	1165-4SSL-P
6	Stainless Steel	128mm/260mm	15 3/8	9/16	1 1/16	M4	1164-4SSL-P
7	Stainless Steel	160mm	11 7/16	9/16	1 1/16	M4	1163-4SSL-P
8	Stainless Steel	64mm	7 1/2	9/16	1 1/16	M4	1162-4SSL-P

⚡ DURABLE FINISH



PROFILE

#	FINISH	CC	L	W	H	TAP	PART NO
1	Polished Chrome	320mm/480mm	23 5/8	11/16	15/16	M4	1154-4026-P
2	Polished Chrome	192mm/320mm	15 3/4	11/16	15/16	M4	1153-4026-P
3	Polished Chrome	96mm/128mm	7 7/8	11/16	15/16	M4	1152-4026-P
4	Stainless Steel	320mm/480mm	23 5/8	11/16	15/16	M4	1157-4SSL-P
5	Stainless Steel	192mm/320mm	15 3/4	11/16	15/16	M4	1156-4SSL-P
6	Stainless Steel	96mm/128mm	7 7/8	11/16	15/16	M4	1155-4026-P

⚡ DURABLE FINISH



LIPS

#	FINISH	CC	L	W	H	TAP	PART NO
1	Polished Chrome	224mm	12 5/8	1 13/16	13/16	M4	1185-1026-C
2	Polished Chrome	160mm	9 7/16	1 13/16	13/16	M4	1183-1026-C
3	Brushed Nickel	224mm	12 5/8	1 13/16	13/16	M4	1184-1BPN-C
4	Brushed Nickel	160mm	9 7/16	1 13/16	13/16	M4	1182-1BPN-C

DESIGNED WITH GREEN IN MIND DURABLE FINISH



## SCOOP

#	FINISH	CC	L	W	H	TAP	PART NO
1	Polished Chrome	224mm	12 5/8	1 13/16	3/4	M4	1198-1026-C
2	Polished Chrome	160mm	9 7/16	1 13/16	3/4	M4	1196-1026-C
3	Polished Chrome	32mm	2 13/16	1 13/16	3/4	M4	1194-1026-C
4	Brushed Nickel	224mm	12 5/8	1 13/16	3/4	M4	1199-1BPN-C
5	Brushed Nickel	160mm	9 7/16	1 13/16	3/4	M4	1197-1BPN-C
6	Brushed Nickel	32mm	2 13/16	1 13/16	3/4	M4	1195-1BPN-C

DESIGNED WITH GREEN IN MIND DURABLE FINISH

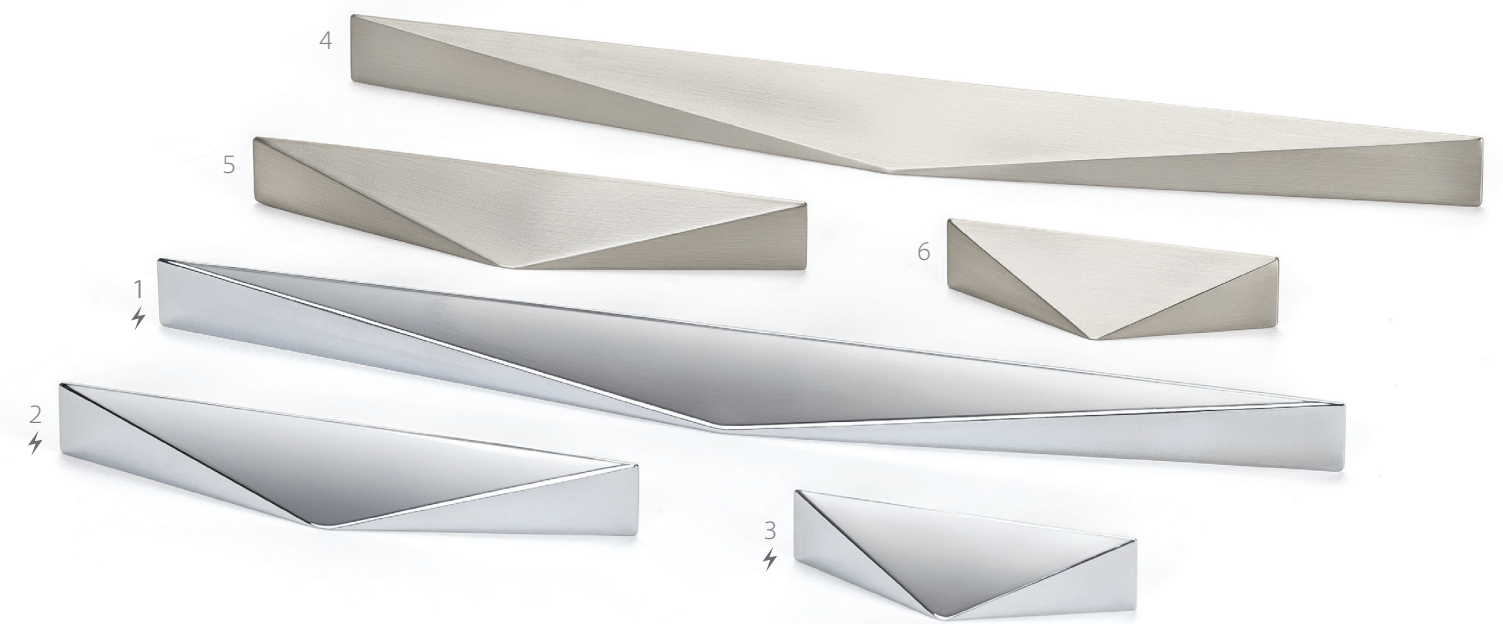

FACET

#	FINISH	CC	L	W	H	TAP	PART NO
1	Polished Chrome	192mm	12 1/4	3/4	3/4	M4	1147-1026-P
2	Polished Chrome	96mm	6	3/4	3/4	M4	1146-1026-P
3	Polished Chrome	32mm	3 7/16	3/4	3/4	M4	1145-1026-P
4	Brushed Nickel	192mm	12 1/4	3/4	3/4	M4	1150-1BPN-P
5	Brushed Nickel	96mm	6	3/4	3/4	M4	1149-1BPN-P
6	Brushed Nickel	32mm	3 7/16	3/4	3/4	M4	1148-1BPN-P

⚡ DURABLE FINISH



R. Christensen  
Premium Hardware Since 1879

Berenson



ARCH

#	FINISH	CC	L	W	H	TAP	PART NO
1	Brushed Nickel	192mm	12 5/8	7/8	3/4	M4	1187-1BPN-C
2	Brushed Nickel	128mm	9 7/16	13/16	13/16	M4	1186-1BPN-C

DESIGNED WITH GREEN IN MIND





FUJI

#	FINISH	CC	L	W	H	TAP	PART NO
1	Polished Chrome	224mm	12 1/2	1 1/4	13/16	M4	1189-1026-C
2	Polished Chrome	160mm	9	1 1/4	13/16	M4	1191-1026-C
3	Brushed Nickel	224mm	12 1/2	1 1/4	13/16	M4	1188-1BPN-C
4	Brushed Nickel	160mm	9	1 1/4	13/16	M4	1190-1BPN-C

DESIGNED WITH GREEN IN MIND
 DURABLE FINISH

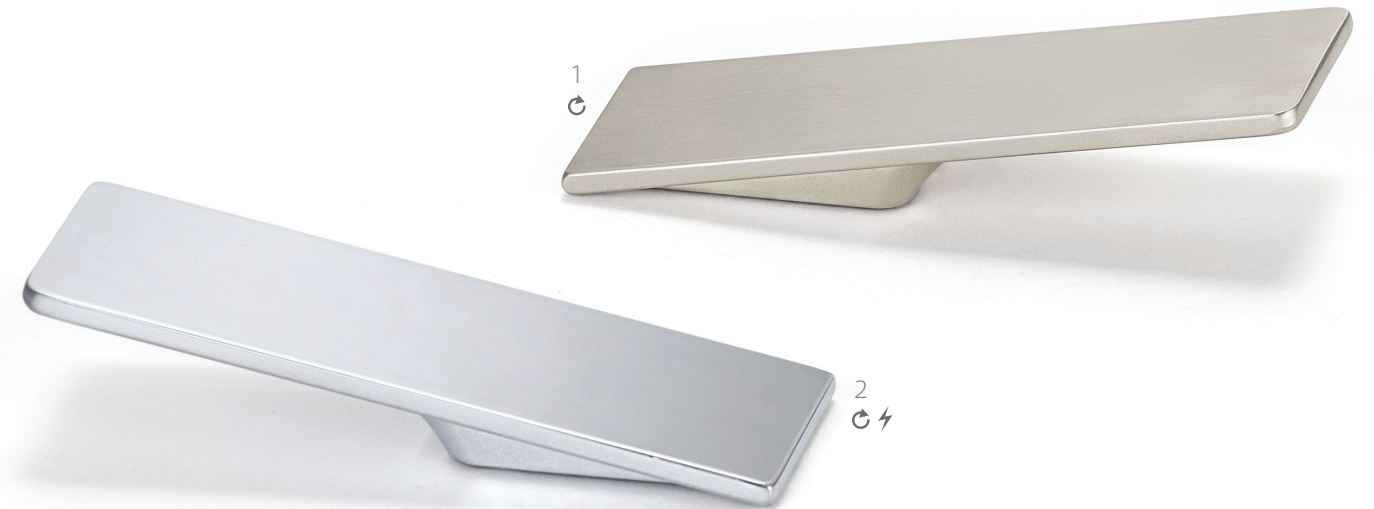

WING

#	FINISH	CC	L	W	H	TAP	PART NO
1	Brushed Nickel	16mm	3 7/8	1 9/16	15/16	M4	1174-1BPN-C
2	Polished Chrome	16mm	3 7/8	1 9/16	15/16	M4	1175-1026-C

♻️ DESIGNED WITH GREEN IN MIND ⚡ DURABLE FINISH



## SPIRAL

#	FINISH	CC	L	W	H	TAP	PART NO
1	Polished Chrome	320mm	13 3/8	3/4	1	M4	1141-1026-P
2	Polished Chrome	240mm	9 3/16	3/4	1	M4	1140-1026-P
3	Polished Chrome	160mm	6 11/16	3/4	1	M4	1139-1026-P
4	Brushed Nickel	320mm	13 3/8	3/4	1	M4	1144-1BPN-P
5	Brushed Nickel	240mm	9 3/16	3/4	1	M4	1143-1BPN-P
6	Brushed Nickel	160mm	6 11/16	3/4	1	M4	1142-1BPN-P

⚡ DURABLE FINISH



ANGLE

#	FINISH	CC	L	W	H	TAP	PART NO
1	Polished Chrome	224mm	9 5/8	1 1/16	1 7/16	M4	1177-1026-C
2	Polished Chrome	192mm	8 3/8	1 1/16	1 7/16	M4	1179-1026-C
3	Polished Chrome	192mm	8 3/8	1 1/16	1 7/16	M4	1181-1026-C
4	Brushed Nickel	224mm	9 5/8	1 3/16	1 7/16	M4	1176-1BPN-C
5	Brushed Nickel	192mm	8 3/8	1 1/16	1 7/16	M4	1178-1BPN-C
6	Brushed Nickel	192mm	8 3/8	1 1/16	1 7/16	M4	1180-1BPN-C

DESIGNED WITH GREEN IN MIND DURABLE FINISH

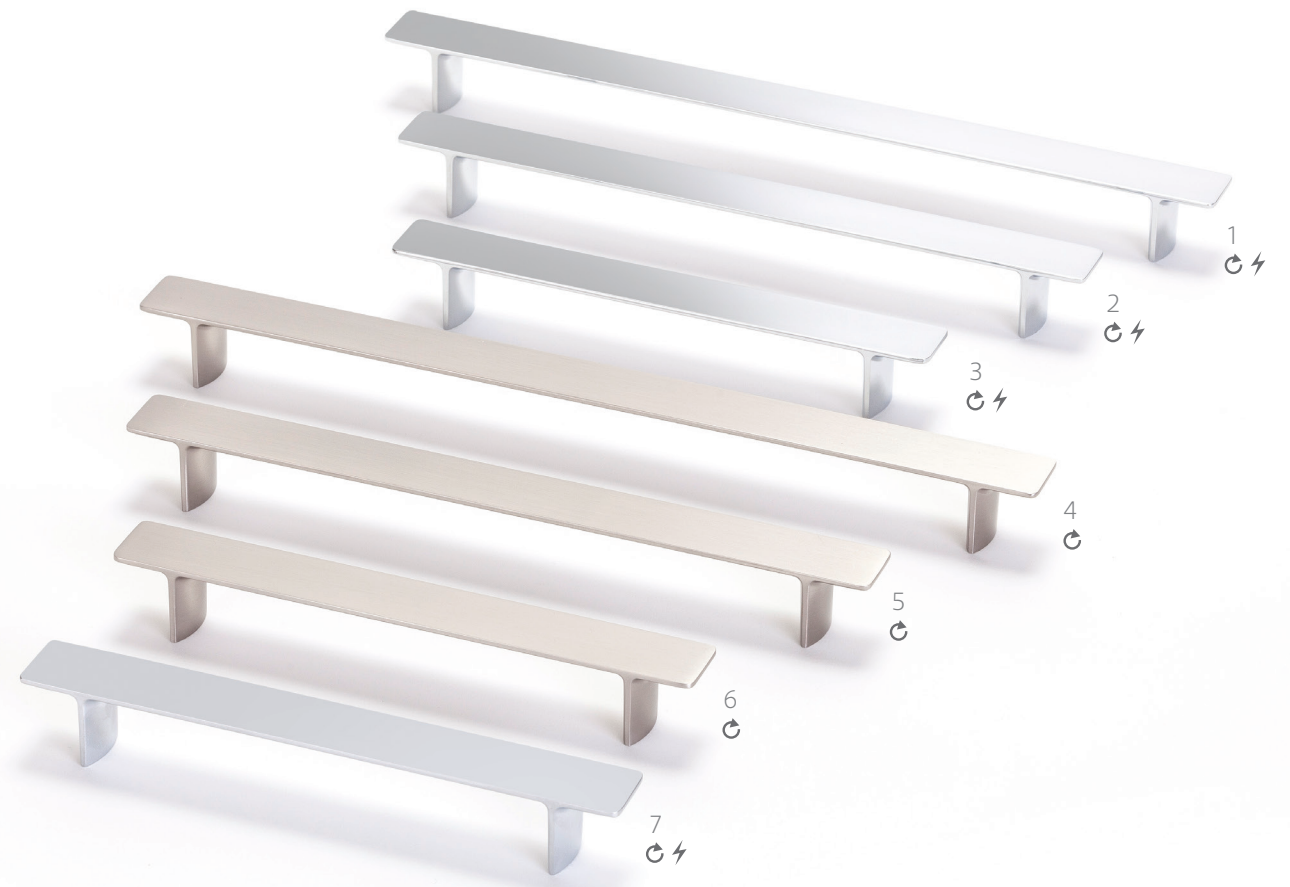

JAZZ

#	FINISH	CC	L	W	H	TAP	PART NO
1	Polished Chrome	288mm	13 1/8	1	1 13/16	M4	9742-1026-C
2	Polished Chrome	224mm	10 1/2	1	1 13/16	M4	9744-1026-C
3	Polished Chrome	160mm	8	1	1 13/16	M4	9264-1026-C
4	Brushed Nickel	288mm	13 1/8	1	1 13/16	M4	9741-1BPN-C
5	Brushed Nickel	224mm	10 1/2	1	1 13/16	M4	9743-1BPN-C
6	Brushed Nickel	160mm	8	1	1 13/16	M4	9263-1BPN-C
7	Dull Chrome	160mm	8	1	1 13/16	M4	9265-10DC-C

DESIGNED WITH GREEN IN MIND DURABLE FINISH



LUNGO

#	FINISH	CC	L	W	H	TAP	PART NO
1	Polished Chrome	448mm	18	1/4	1 1/2	M4	9700-4026-C
	Polished Chrome	384mm	15 1/2	1/4	1 1/2	M4	9726-4026-C*
2	Polished Chrome	288mm	11 1/16	1/4	1 1/2	M4	9728-4026-C
	Polished Chrome	224mm	9 1/8	1/4	1 1/2	M4	9730-4026-C*
3	Polished Chrome	192mm	7 15/16	1/4	1 1/2	M4	9732-4026-C
	Polished Chrome	160mm	6 5/8	1/4	1 1/2	M4	9734-4026-C*
4	Polished Chrome	128mm	5 3/8	1/4	1 1/2	M4	9736-4026-C
	Polished Chrome	32mm	1 5/8	1/4	1 1/2	M4	9698-1026-C*
	Brushed Nickel	448mm	18	1/4	1 1/2	M4	9699-4BPN-C*
5	Brushed Nickel	384mm	15 1/2	1/4	1 1/2	M4	9725-4BPN-C
	Brushed Nickel	288mm	11 1/16	1/4	1 1/2	M4	9727-4BPN-C*
6	Brushed Nickel	224mm	9 1/8	1/4	1 1/2	M4	9729-4BPN-C
	Brushed Nickel	192mm	7 15/16	1/4	1 1/2	M4	9731-4BPN-C*
7	Brushed Nickel	160mm	6 5/8	1/4	1 1/2	M4	9733-4BPN-C
	Brushed Nickel	128mm	5 3/8	1/4	1 1/2	M4	9735-4BPN-C*
8	Brushed Nickel	32mm	1 5/8	1/4	1 1/2	M4	9697-1BPN-C

DESIGNED WITH GREEN IN MIND DURABLE FINISH

\* Size not shown; visit website for photo



EDGE

#	FINISH	CC	L	W	H	TAP	PART NO
1	Dull Chrome	160mm	7 3/8	5/16	1 3/8	M4	9271-10DC-C
2	Dull Chrome	96mm	4 7/8	5/16	1 3/16	M4	9274-10DC-C
3	Brushed Nickel	160mm	7 3/8	5/16	1 3/8	M4	9269-1BPN-C
4	Brushed Nickel	96mm	4 7/8	5/16	1 3/16	M4	9272-1BPN-C
5	Polished Chrome	160mm	7 3/8	5/16	1 3/8	M4	9270-1026-C
6	Polished Chrome	96mm	4 7/8	5/16	1 3/16	M4	9273-1026-C

♻️ DESIGNED WITH GREEN IN MIND ⚡ DURABLE FINISH

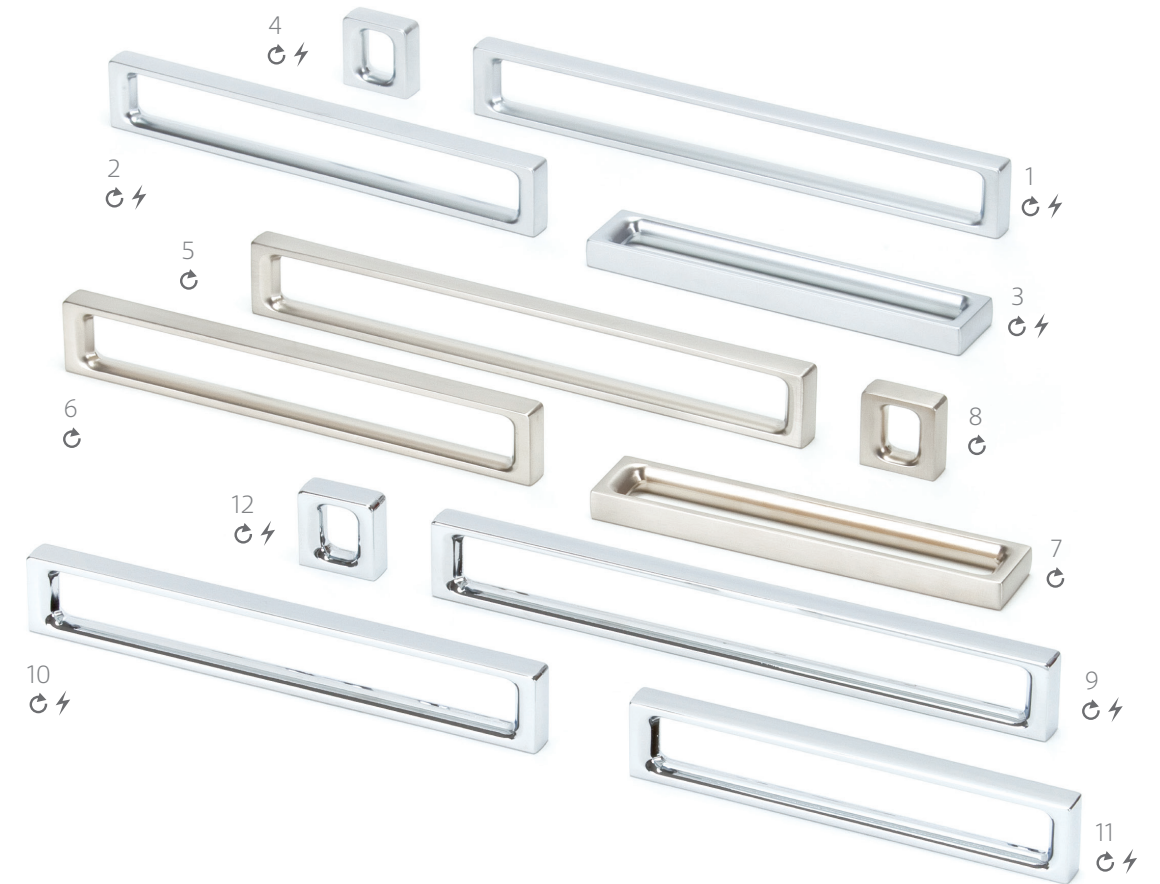

DUAL

#	FINISH	CC	L	W	H	TAP	PART NO
1	Dull Chrome	192mm	7 7/8	3/8	1	M4	9304-10DC-C
2	Dull Chrome	160mm	6 5/8	3/8	1	M4	9307-10DC-C
3	Dull Chrome	128mm	5 3/8	3/8	1	M4	9310-10DC-C
4	Dull Chrome	16mm	1	3/8	1	M4	9314-10DC-C
5	Brushed Nickel	192mm	7 7/8	3/8	1	M4	9302-1BPN-C
6	Brushed Nickel	160mm	6 5/8	3/8	1	M4	9305-1BPN-C
7	Brushed Nickel	128mm	5 3/8	3/8	1	M4	9308-1BPN-C
8	Brushed Nickel	16mm	1	3/8	1	M4	9311-1BPN-C
9	Polished Chrome	192mm	7 7/8	3/8	1	M4	9303-1026-C
10	Polished Chrome	160mm	6 5/8	3/8	1	M4	9306-1026-C
11	Polished Chrome	128mm	5 3/8	3/8	1	M4	9309-1026-C
12	Polished Chrome	16mm	1	3/8	1	M4	9313-1026-C

DESIGNED WITH GREEN IN MIND DURABLE FINISH



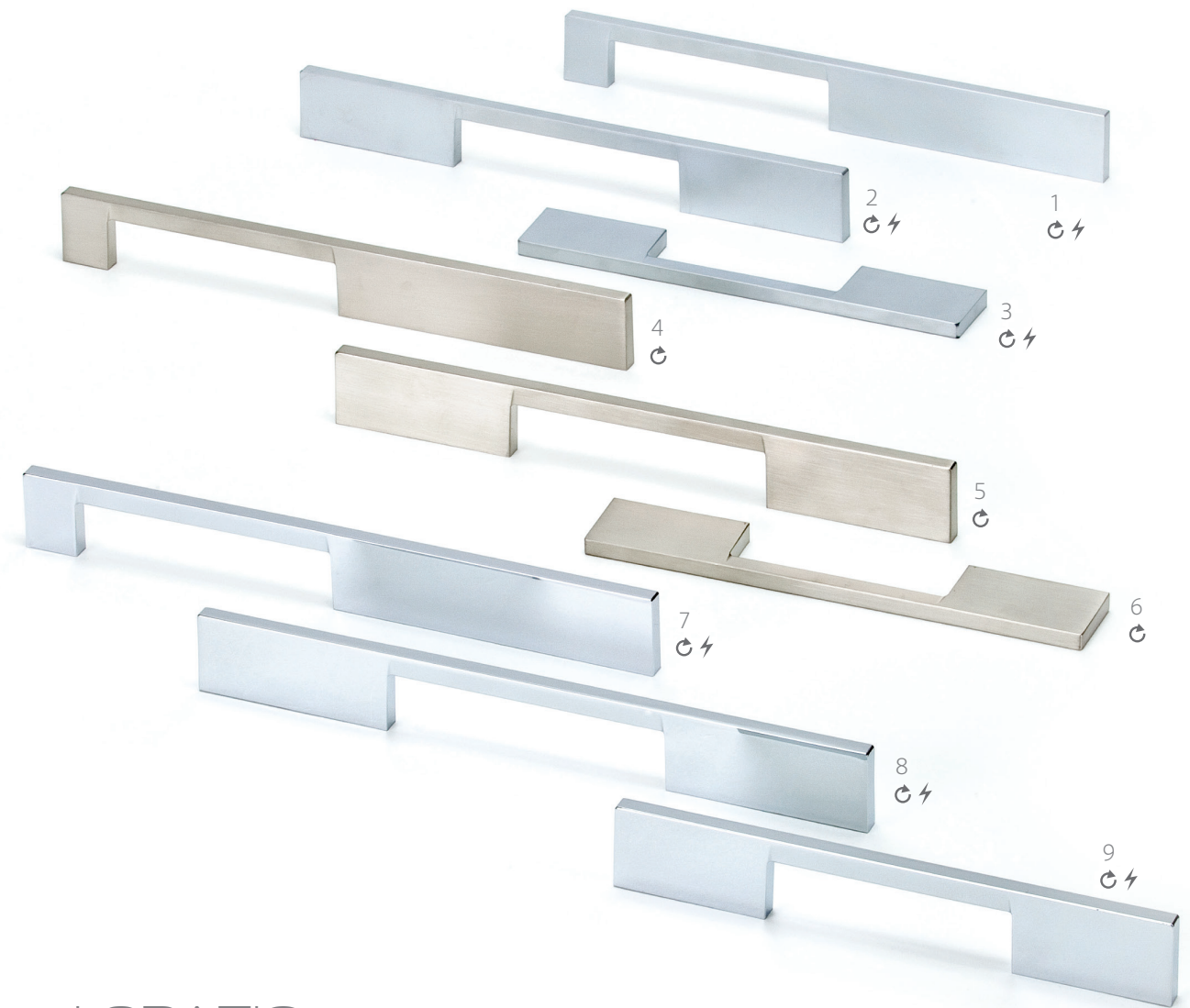

I-SPAZIO

#	FINISH	CC	L	W	H	TAP	PART NO
1	Dull Chrome	192mm	10 1/4	1/4	1 1/4	M4	9295-10DC-C
2	Dull Chrome	192mm	10 1/4	1/4	1 1/4	M4	9298-10DC-C
3	Dull Chrome	128mm	7 7/8	1/4	1 1/4	M4	9301-10DC-C
4	Brushed Nickel	192mm	10 1/4	1/4	1 1/4	M4	9293-1BPN-C
5	Brushed Nickel	192mm	10 1/4	1/4	1 1/4	M4	9296-1BPN-C
6	Brushed Nickel	128mm	7 7/8	1/4	1 1/4	M4	9299-1BPN-C
7	Polished Chrome	192mm	10 1/4	1/4	1 1/4	M4	9294-1026-C
8	Polished Chrome	192mm	10 1/4	1/4	1 1/4	M4	9297-1026-C
9	Polished Chrome	128mm	7 7/8	1/4	1 1/4	M4	9300-1026-C

DESIGNED WITH GREEN IN MIND    
 DURABLE FINISH  
 Center pull on drawer before drilling holes

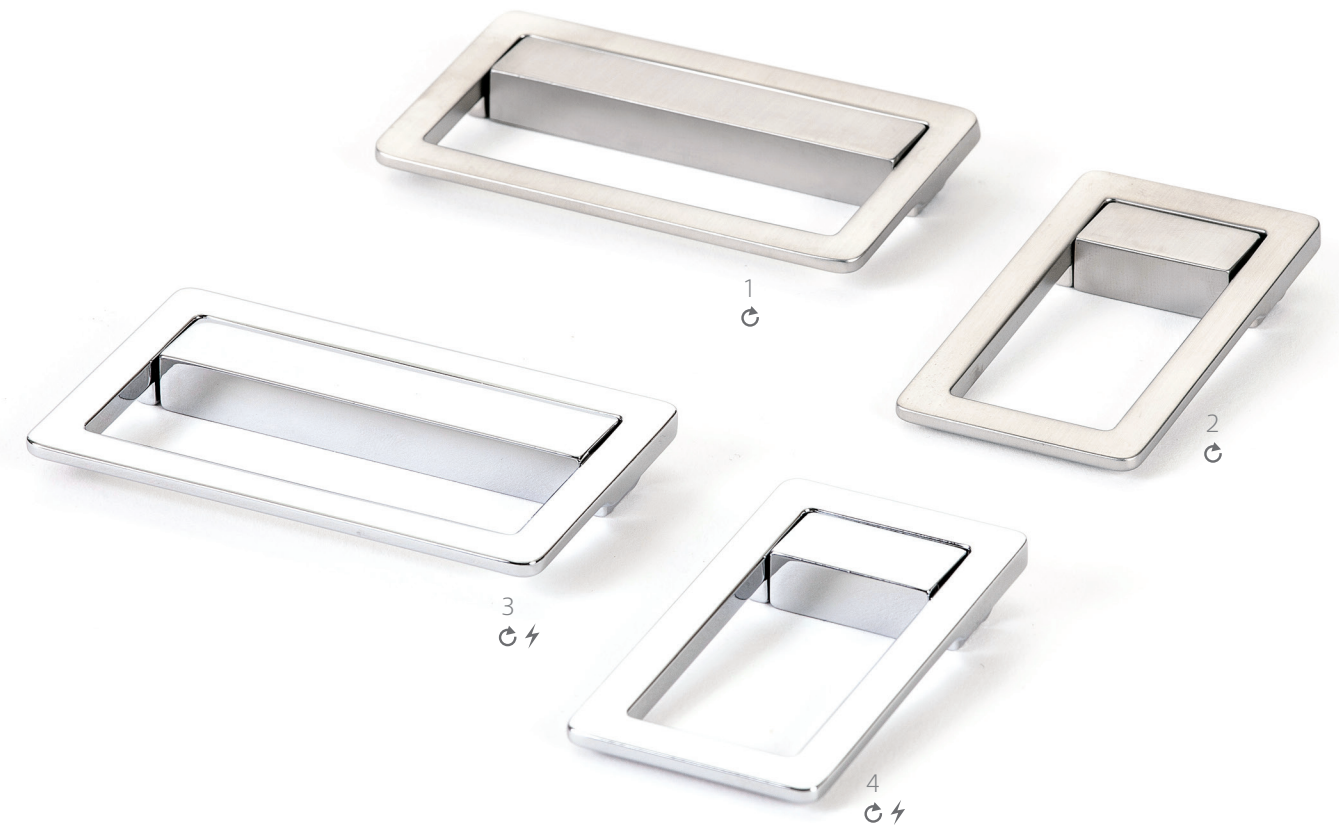

UP

#	FINISH	CC	L	W	H	TAP	PART NO
1	Brushed Nickel	64mm	3 9/16	3/8	2	M4	9737-1BPN-C
2	Brushed Nickel	16mm	1 5/8	3/8	2 15/16	M4	9739-1BPN-C
3	Polished Chrome	64mm	3 9/16	3/8	2	M4	9738-1026-C
4	Polished Chrome	16mm	1 5/8	3/8	2 15/16	M4	9740-1026-C

♻️ DESIGNED WITH GREEN IN MIND

⚡ DURABLE FINISH

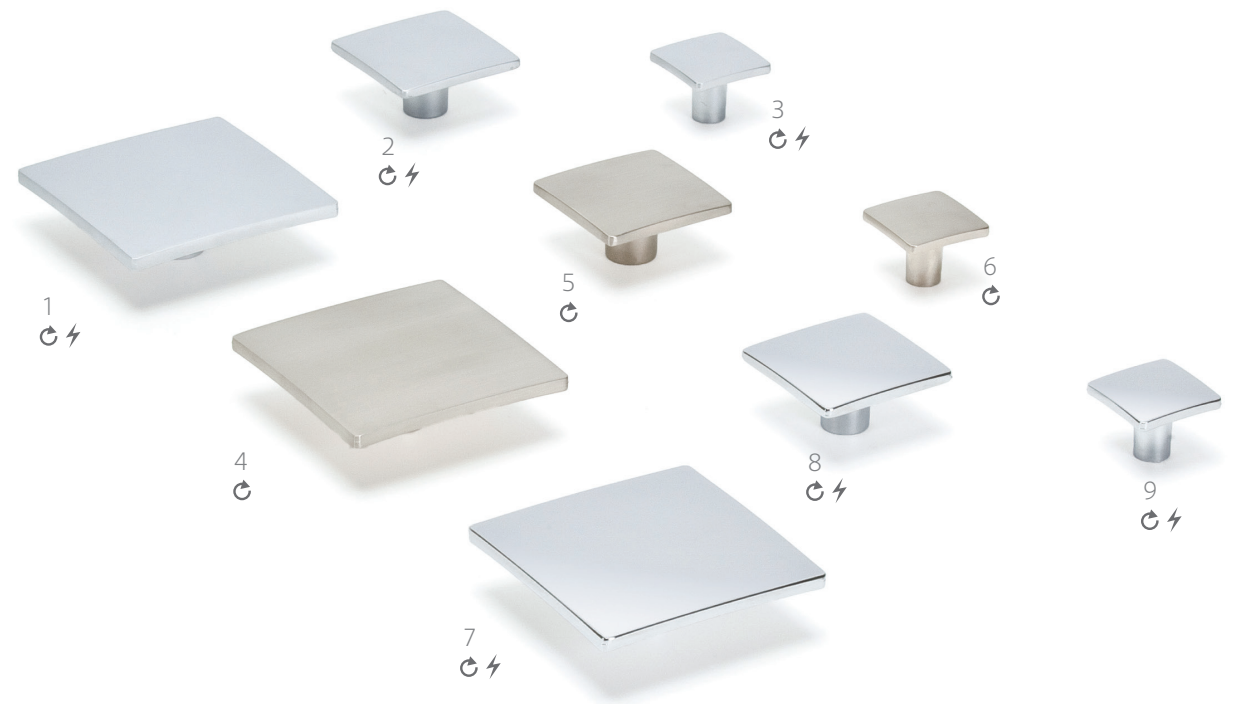

WAVE

#	FINISH	L	W	H	TAP	PART NO
1	Dull Chrome	3 1/8	3 1/8	1 1/8	M4	9317-10DC-C
2	Dull Chrome	1 15/16	1 15/16	1	M4	9320-10DC-C
3	Dull Chrome	1 1/4	1 1/4	1	M4	9323-10DC-C
4	Brushed Nickel	3 1/8	3 1/8	1 1/8	M4	9315-1BPN-C
5	Brushed Nickel	1 15/16	1 15/16	1	M4	9318-1BPN-C
6	Brushed Nickel	1 1/4	1 1/4	1	M4	9321-1BPN-C
7	Polished Chrome	3 1/8	3 1/8	1 1/8	M4	9316-1026-C
8	Polished Chrome	1 15/16	1 15/16	1	M4	9319-1026-C
9	Polished Chrome	1 1/4	1 1/4	1	M4	9322-1026-C

♻️ DESIGNED WITH GREEN IN MIND ⚡ DURABLE FINISH

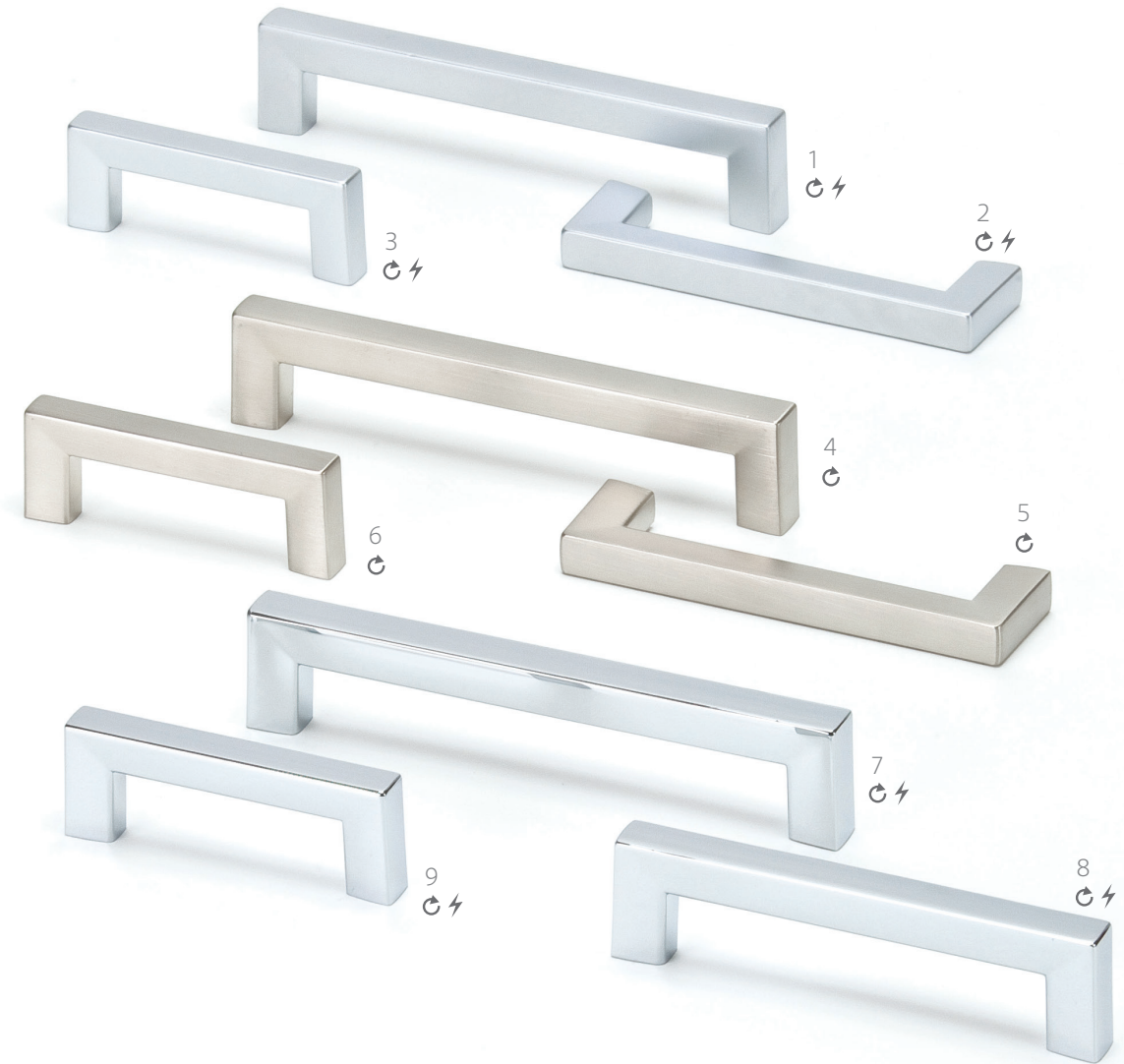

SQUARE

#	FINISH	CC	L	W	H	TAP	PART NO
1	Dull Chrome	128mm	5 3/4	1/2	1 3/16	M4	9286-10DC-C
2	Dull Chrome	96mm	4 1/2	7/16	1 3/16	M4	9289-10DC-C
3	Dull Chrome	64mm	3 1/8	3/8	1 3/16	M4	9292-10DC-C
4	Brushed Nickel	128mm	5 3/4	1/2	1 3/16	M4	9284-1BPN-C
5	Brushed Nickel	96mm	4 1/2	7/16	1 3/16	M4	9287-1BPN-C
6	Brushed Nickel	64mm	3 1/8	3/8	1 3/16	M4	9290-1BPN-C
7	Polished Chrome	128mm	5 3/4	1/2	1 3/16	M4	9285-1026-C
8	Polished Chrome	96mm	4 1/2	7/16	1 3/16	M4	9288-1026-C
9	Polished Chrome	64mm	3 1/8	3/8	1 3/16	M4	9291-1026-C

♻️ DESIGNED WITH GREEN IN MIND ⚡ DURABLE FINISH

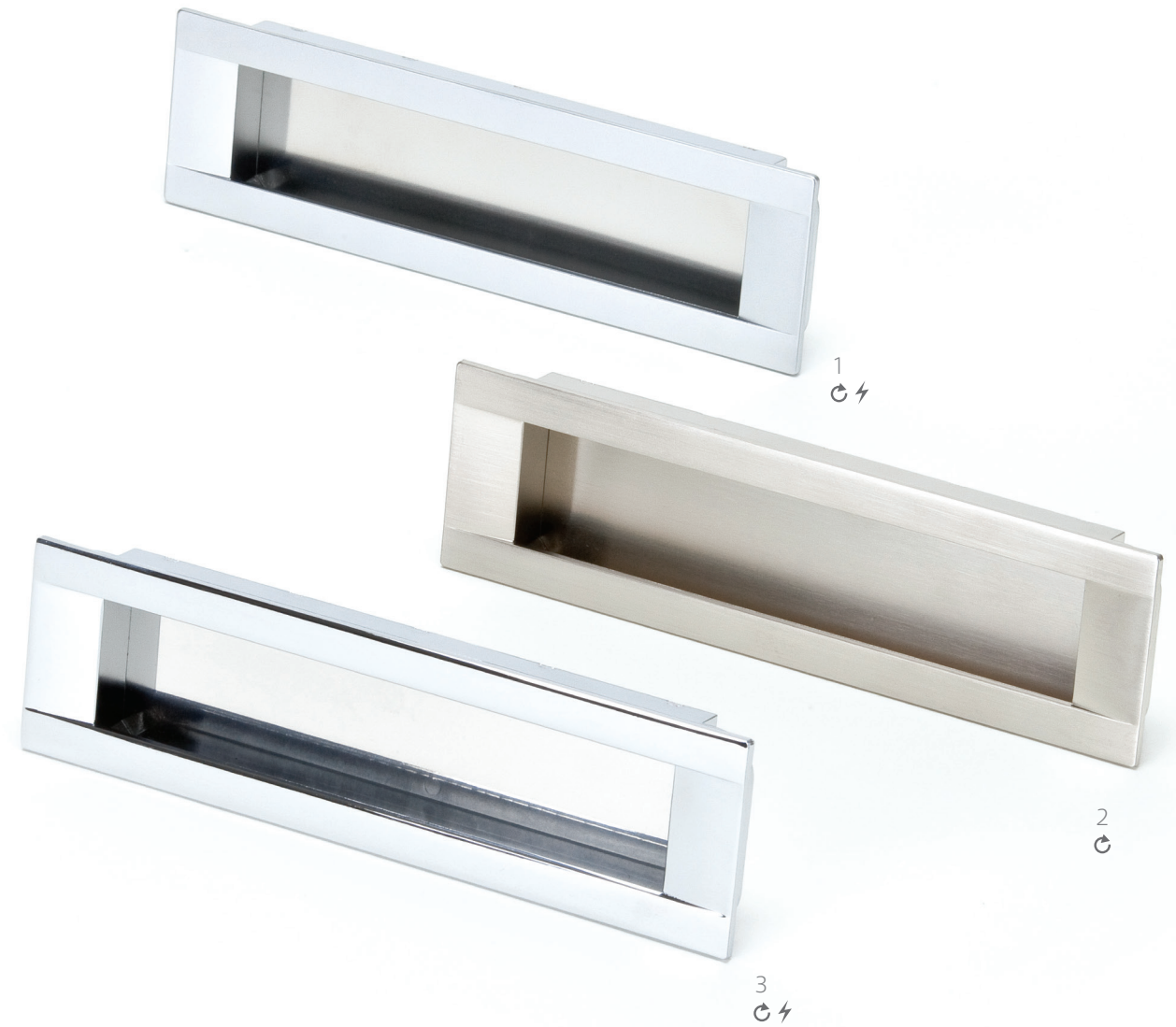

SEIZE

#	FINISH	CC	L	W	H	TAP	PART NO
1	Dull Chrome	160mm	7 1/16	2	7/8	M4	9283-10DC-C
2	Brushed Nickel	160mm	7 1/16	2	7/8	M4	9281-1BPN-C
3	Polished Chrome	160mm	7 1/16	2	7/8	M4	9282-1026-C

♻️ DESIGNED WITH GREEN IN MIND ⚡ DURABLE FINISH

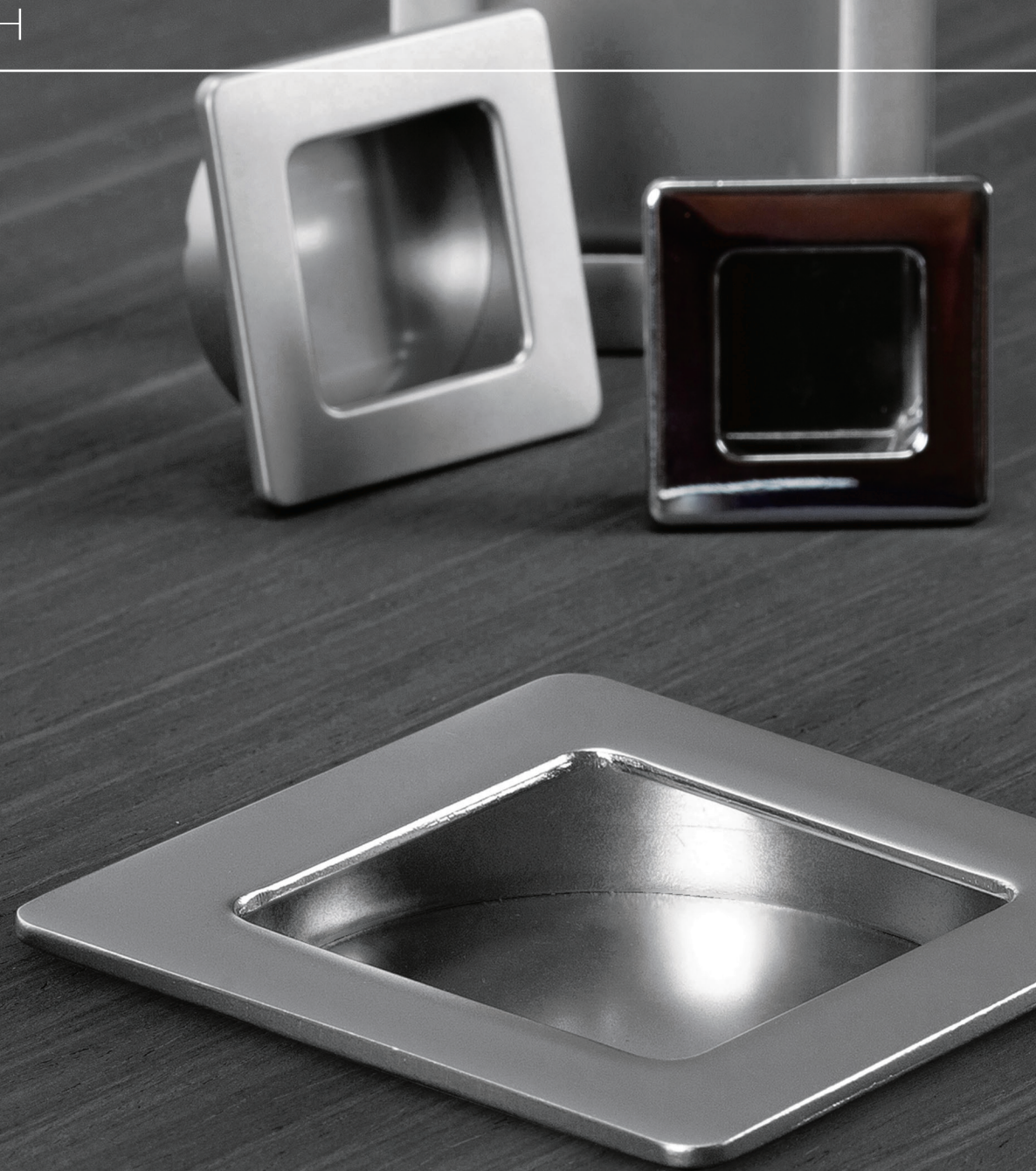

R. Christensen  
Premium Hardware Since 1879

Berenson



STYLUS

#	FINISH	L	W	H	BORE	PART NO
1	Dull Chrome	2 1/2	2 1/2	1/2	60mm ø x 11mm D	9326-10DC-C
2	Dull Chrome	1 7/8	1 7/8	1/2	45mm ø x 11mm D	9329-10DC-C
3	Dull Chrome	1 1/2	1 1/2	1/2	35mm ø x 11mm D	9332-10DC-C
4	Dull Chrome	1 1/8	1 1/8	1/2	26mm ø x 11mm D	9335-10DC-C
5	Brushed Nickel	2 1/2	2 1/2	1/2	60mm ø x 11mm D	9324-1BPN-C
6	Brushed Nickel	1 7/8	1 7/8	1/2	45mm ø x 11mm D	9327-1BPN-C
7	Brushed Nickel	1 1/2	1 1/2	1/2	35mm ø x 11mm D	9330-1BPN-C
8	Brushed Nickel	1 1/8	1 1/8	1/2	26mm ø x 11mm D	9333-1BPN-C
9	Polished Chrome	2 1/2	2 1/2	1/2	60mm ø x 11mm D	9325-1026-C
10	Polished Chrome	1 7/8	1 7/8	1/2	45mm ø x 11mm D	9328-1026-C
11	Polished Chrome	1 1/2	1 1/2	1/2	35mm ø x 11mm D	9331-1026-C
12	Polished Chrome	1 1/8	1 1/8	1/2	26mm ø x 11mm D	9334-1026-C

♻️ DESIGNED WITH GREEN IN MIND ⚡ DURABLE FINISH



R. Christensen  
Premium Hardware Since 1879



RECESS

#	FINISH	CC	L	W	H	TAP	PART NO
1	Brushed Nickel	202mm	8 3/8	3/4	1 13/16	M4	9794-1BPN-P
2	Brushed Nickel	202mm	8 3/8	3/16	1 7/8	M4	9795-1BPN-P
3	Dull Chrome	128mm	7 1/16	11/16	5/8		9797-10DC-B
4	Satin Nickel	128mm	7 1/16	11/16	5/8		9796-1015-B



SLIDE

#	FINISH	L	W	H	TAP	PART NO
1	Dull Chrome	2 1/8	2	1 7/16	M4	9280-10DC-P
2	Dull Chrome	2 1/8	1	1 3/16	M4	9277-10DC-P
3	Brushed Nickel	2 1/8	2	1 7/16	M4	9278-1BPN-P
4	Brushed Nickel	2 1/8	1	1 3/16	M4	9275-1BPN-P
5	Polished Chrome	2 1/8	2	1 7/16	M4	9279-1026-P
6	Polished Chrome	2 1/8	1	1 3/16	M4	9276-1026-P

♻️ DESIGNED WITH GREEN IN MIND ⚡ DURABLE FINISH



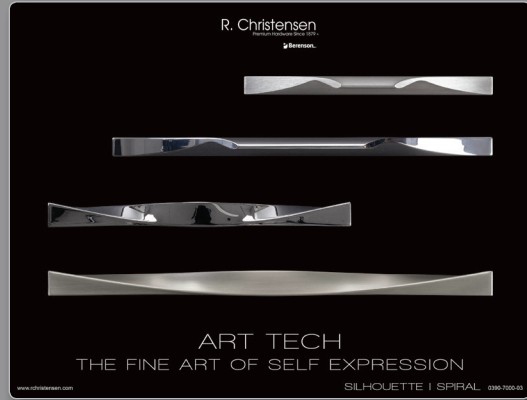

SILHOUETTE | SPIRAL 0390-7000-03



PROFILE | FACET 0389-7000-03



LUNGO 0353-7000-03

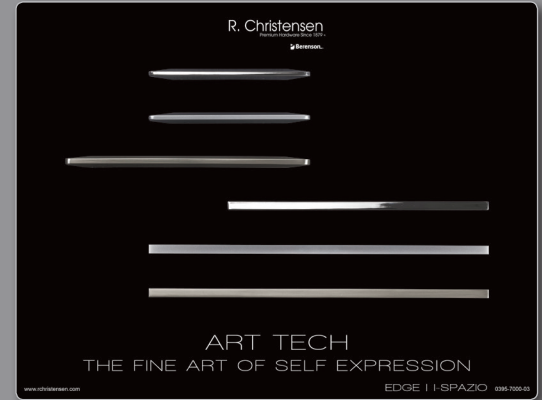

EDGE | I-SPAZIO 0395-7000-03



ARCH | LIPS 0393-7000-03



FUJI | SCOOP 0392-7000-03

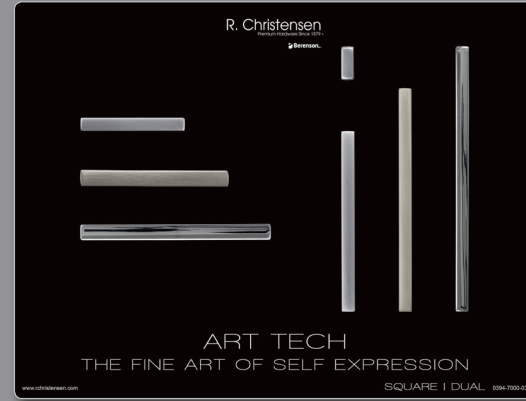

SQUARE | DUAL 0394-7000-03



SLIDE | UP 0348-7000-03



ANGLE | WING 0391-7000-03

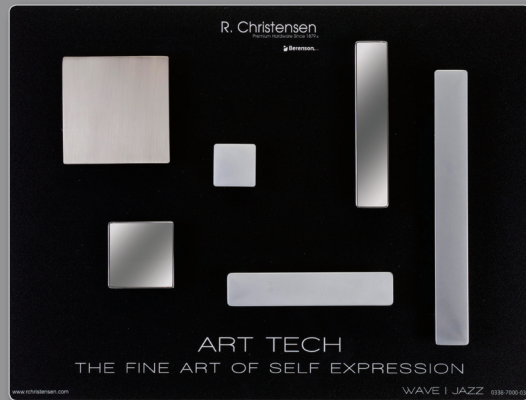

WAVE | JAZZ 0345-7000-03



STYLUS | SEIZE 0352-7000-03

Display boards are sized to fit in a Berenson 10- or 24-board display tower.

Visit [BerensonHardware.com](http://BerensonHardware.com) or contact Berenson to explore merchandising options.

11 13/16"

15 13/16"

**BECOME A DEALER** Contemporary hardware designs that meet the expectations of discerning homeowners, R. Christensen knobs and pulls are the premium brand from Berenson Corp. Our line of more than 2,000 products includes a variety of specialty hardware designs, finishes, sizes and price points to meet your design needs. What's more, Berenson will meet your needs for prompt, reliable

and complete delivery. Our fulfillment record stands: 97% of all items ship within 24 hours. Berenson decorative hardware is available across the USA through selected resellers. To open an account, learn more about becoming a dealer or to explore merchandising options available from Berenson, visit us at [www.berensonhardware.com](http://www.berensonhardware.com) or call our service team today at 1-800-333-0578.

ART TECH

R. Christensen  
Premium Hardware Since 1879

 Berenson



# R. Christensen

Premium Hardware Since 1879



2495 Main Street, Suite 111 | Buffalo, NY  
Phone: 800.333.0578 | Fax: 716.833.2402  
Email: [Info@RChristensen.com](mailto:Info@RChristensen.com)



Look for R. Christensen® on the Berenson® Houzz, Facebook, Twitter and Pinterest pages

© 2016 Berenson Corp.